

## Perimeter seals

# High performance solutions for door frames

Our range of perimeter seals has been curated to offer solutions for a **wide range of gap sizes, fixing locations and applications**. This includes rebated, self-adhesive and surface-mounted options for both door stops and frame reveals. Some seals act as compression seals, shaped so that they compress against the door when it is closed. Others perform as a sweep seal, sweeping against the door edge as the door moves into a closed position.

The athmer range includes seals that can be used at the head, jambs and the meeting stile of doors. There are solutions for hinged and sliding doors as well as for timber, metal and glass surfaces. Their main purpose is to provide an effective barrier against sound transfer between the door and door frame, as well as smoke, air, light, dirt, dust and odours. They can also effectively muffle door closing noise. They are the perfect accompaniment to our range of drop seals and an **essential component in an acoustic door assembly** targeting acoustic performance.



## Perimeter seals

# Schall-Ex® AP 1015 TE

- / door stop-rebated compression seal
- / suitable for sound insulation
- / suitable for smoke sealing



## TECHNICAL DATA

Application	timber frame rebates
Gasket material	TPE
Working temperature range	-40°C to +180°C

## DIMENSIONS

Width x height	12 x 12.5 mm
Fitting tolerance range	4.5 - 5.5 mm
Standard lengths	50m coil

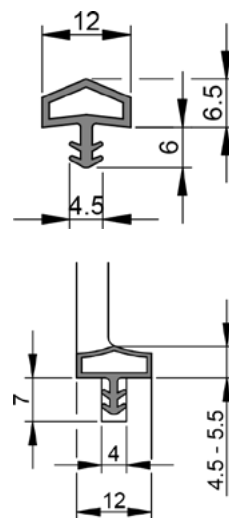

## FIXING

Fixing	into a groove in the door stop
--------	--------------------------------

## COLORS

COLORS	ART.NO.
Black	P160069
Brown	P160071
White	P160072
Beige	P160070

# Schall-Ex® AP 1018 TE

- / door stop-rebated compression seal
- / suitable for sound insulation
- / suitable for smoke sealing

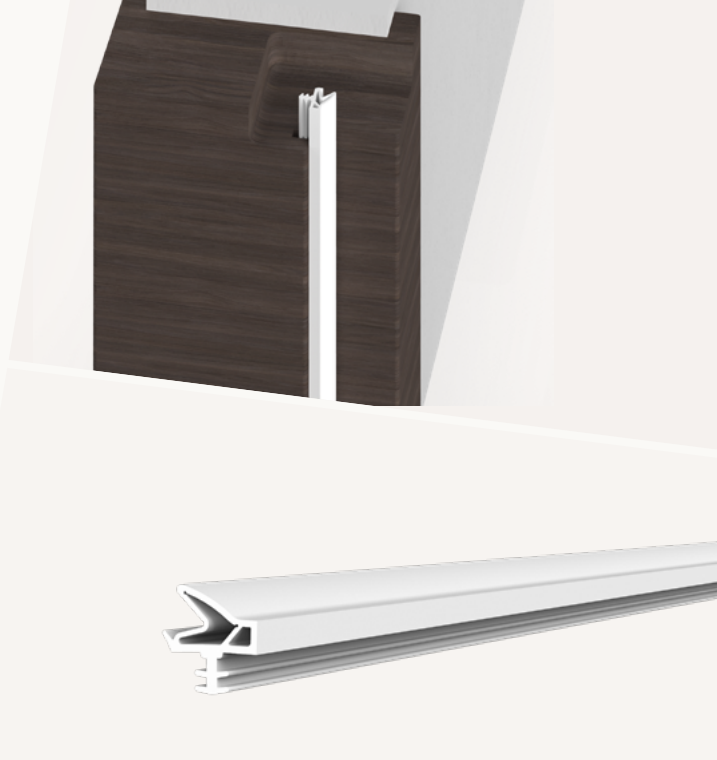

## TECHNICAL DATA

Application	timber frame rebates
Gasket material	TPE
Working temperature range	-40°C to +180°C

## DIMENSIONS

Width x height	12 x 13 mm
Fitting tolerance range	4.5 - 6.5 mm
Standard lengths	25m or 100m coil

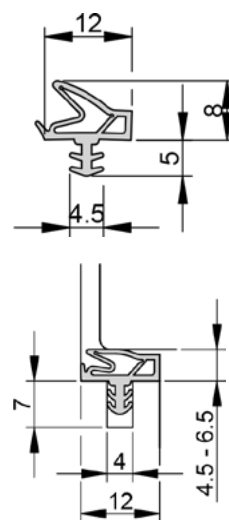

## FIXING

Fixing	into a groove in the door stop
--------	--------------------------------

## PERFORMANCE & CERTIFICATES

Acoustic	49dB with 5mm gap
----------	-------------------

## COLORS

## ART.NO.

Black	P160005
Brown	P160007
White	P160008
Beige	P160006

# Schall-Ex® AP 1018 S

- / door stop-rebated compression seal
- / suitable for sound insulation
- / suitable for smoke sealing



## TECHNICAL DATA

Application	timber frame rebates
Gasket material	silicone
Working temperature range	-60°C to +250°C

## DIMENSIONS

Width x height	12 x 13 mm
Fitting tolerance range	4.5 - 6.5 mm
Standard lengths	2 * 25m coil

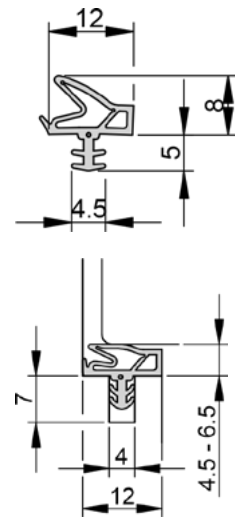

## FIXING

Fixing	into a groove in the door stop
--------	--------------------------------

## PERFORMANCE & CERTIFICATES

Acoustic	49dB with 5mm gap
----------	-------------------

## COLORS

## ART.NO.

Black	P160001
Brown	P160003
White	P160004
Beige	P160002

# Schall-Ex® AP 1019 TE

- / door stop-rebated compression seal
- / suitable for sound insulation
- / suitable for smoke sealing



## TECHNICAL DATA

Application	timber frame rebates
Gasket material	TPE
Working temperature range	-40°C to +180°C

## DIMENSIONS

Width x height	12 x 14 mm
Fitting tolerance range	5 - 7 mm
Standard lengths	25m coil, 150m coil

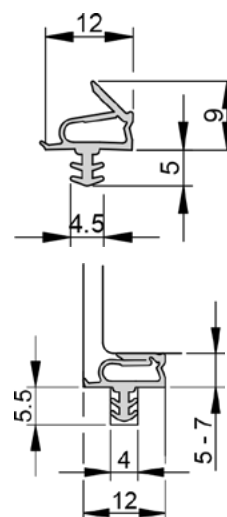

## FIXING

Fixing	into a groove in the door stop
--------	--------------------------------

## PERFORMANCE & CERTIFICATES

Acoustic	50dB with 5mm gap
----------	-------------------

## COLORS

## ART.NO.

Black	P160009
Brown	P160011
White	P160012
Beige	P160010

# PS 2115 S

- / door stop-rebated compression seal
- / suitable for sound insulation
- / suitable for smoke sealing

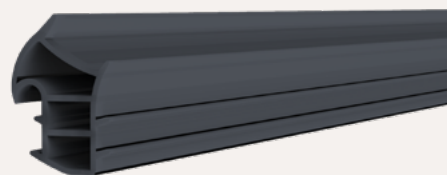

## TECHNICAL DATA

Application	metal frame rebates
Gasket material	silicone
Working temperature range	-40°C to +200°C

## DIMENSIONS

Width x height	12 x 13 mm
Fitting tolerance range	4 - 7 mm
Standard lengths	100m coil

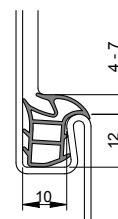
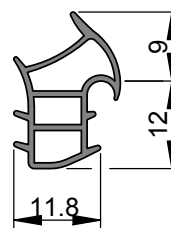

## FIXING

Fixing	into a groove in the door stop
--------	--------------------------------

## PERFORMANCE & CERTIFICATES

Acoustic	49dB with 5mm gap
----------	-------------------

## COLORS

## ART.NO.

Black	P160144
Brown	P160141
White	P160143
Grey	P160142

## PS 0402 S

- / door stop-rebated bubble compression seal
- / suitable for sound insulation
- / suitable for smoke sealing

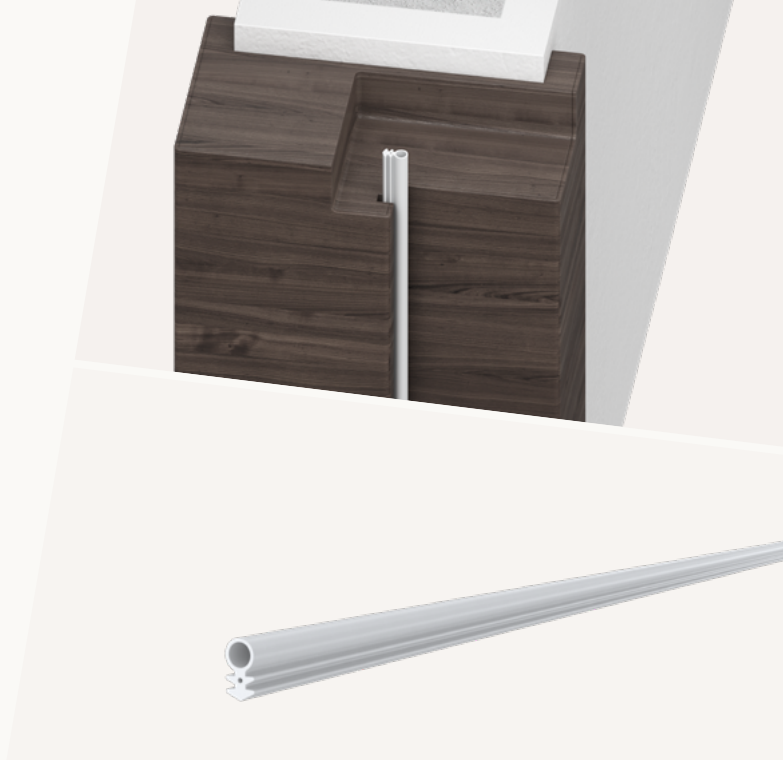

### TECHNICAL DATA

Application	timber frame rebates
Gasket material	silicone
Working temperature range	-60°C to +250°C

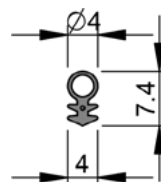

### DIMENSIONS

Width x height	4 x 7.4 mm
Fitting tolerance range	1.5 - 2.5 mm
Standard lengths	100m coil

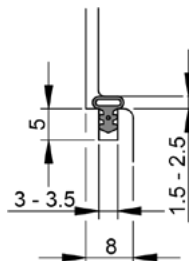

### FIXING

Fixing	into a groove in the door stop
--------	--------------------------------

### COLORS

COLORS	ART.NO.
Black	P160027
Brown	P160029
White	P160028



# PS 1206 S

- / door stop-rebated compression seal
- / ensures soft closing of the door
- / suitable for sound insulation & smoke sealing



## TECHNICAL DATA

Application	timber frame rebates
Gasket material	silicone, self-extinguishing
Working temperature range	-40°C to +180°C

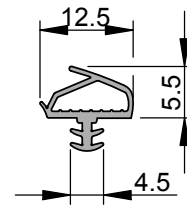

## DIMENSIONS

Width x height	12.5 x 5.5 mm
Fitting tolerance range	3 - 4.5 mm
Standard lengths	100 m coil

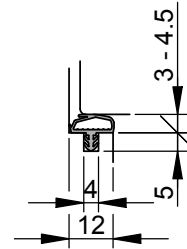

## FIXING

Fixing	into a groove in the door stop
--------	--------------------------------

## COLORS

COLORS	ART.NO.
Black	P160149
White	P160150
Brown	P160221
Dark brown	P160148
Grey	P160222
Cream	P160223

# PS 0704 TE

- / door stop-rebated bubble compressic
- / suitable for sound insulation
- / suitable for smoke protection

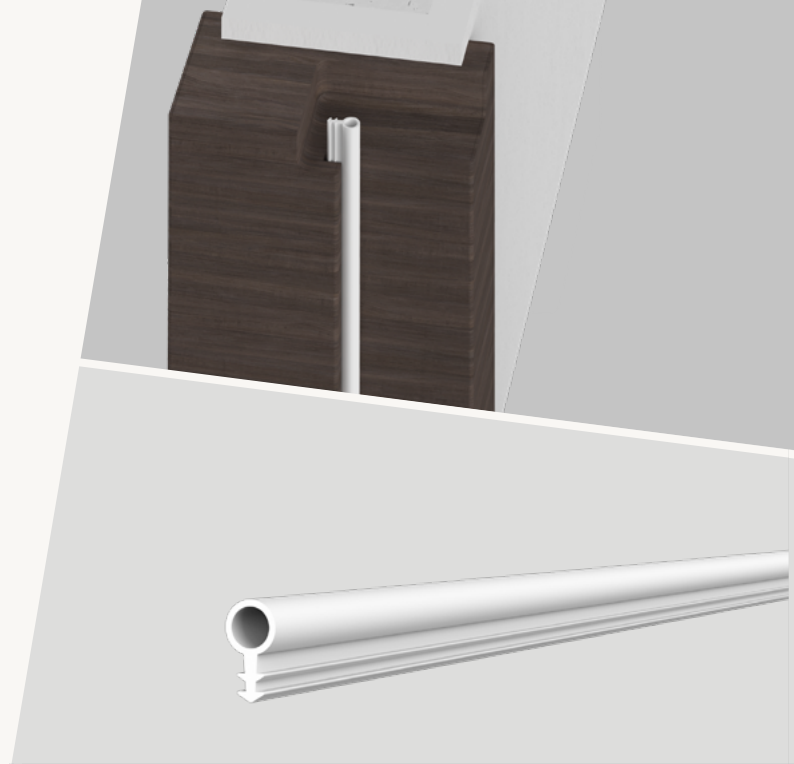

## TECHNICAL DATA

Application	timber frame rebates
Gasket material	TPE
Working temperature	-20°C to +60°C

## DIMENSIONS

Width x height	7 x 12 mm
Fitting tolerance range	4 - 6.5 mm
Standard lengths	250 m coil

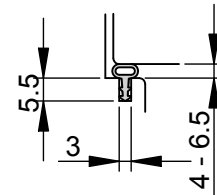
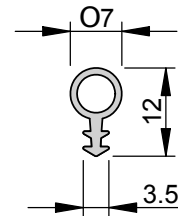

## FIXING

Fixing	into a groove in the door stop
--------	--------------------------------

## COLORS

COLORS	ART.NO.
Dark Brown	P160203
Brown	P160204
Black	P160205
White	P160206
Grey	P160208
Cream	P160207

## PS 0604 S

- / door stop-rebated bubble compression seal
- / suitable for sound insulation
- / suitable for smoke sealing

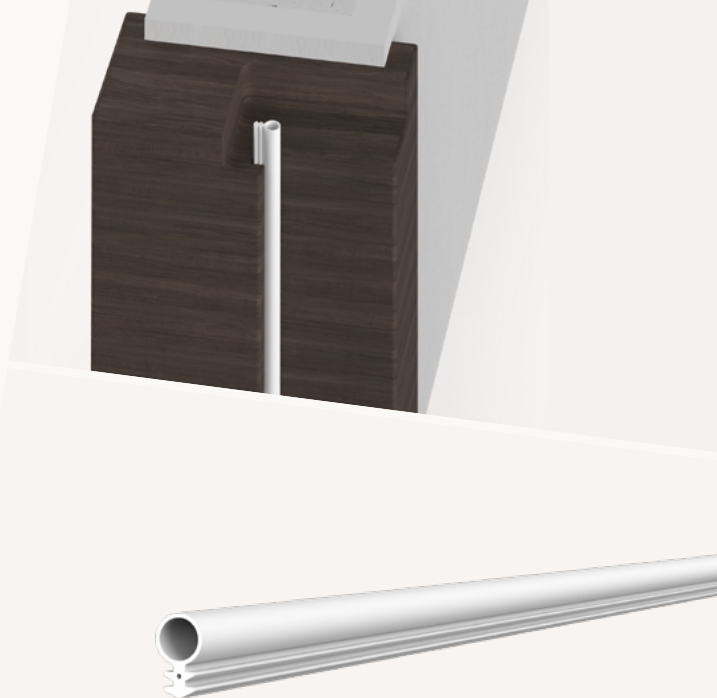

### TECHNICAL DATA

Application	timber frame rebates
Gasket material	silicone
Working temperature range	-60°C to +250°C

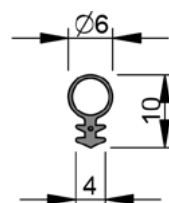

### DIMENSIONS

Width x height	6 x 10 mm
Fitting tolerance range	3 - 5 mm
Standard lengths	100m coil

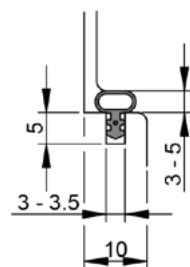

### FIXING

Fixing	into a groove in the door stop
--------	--------------------------------

### COLORS

COLORS	ART.NO.
Black	P160030
Brown	P160032
White	P160031

## Sili II

- / door stop-rebated perimeter seal
- / suitable for sound insulation
- / suitable for smoke protection

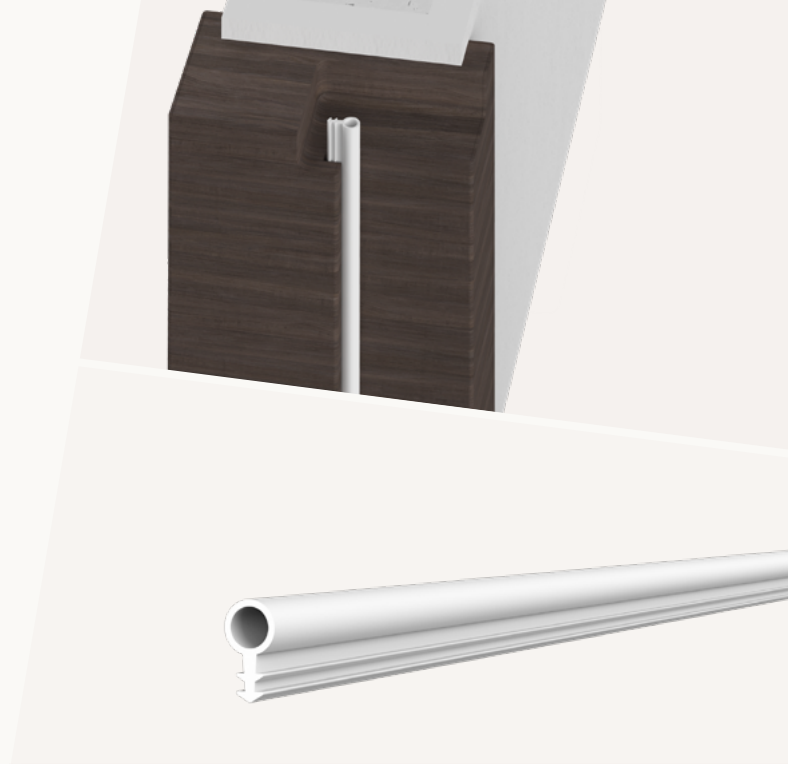

### TECHNICAL DATA

Application	timber frame rebates
Gasket material	flexible PVC

### DIMENSIONS

Width x height	6.5 x 12 mm
Fitting tolerance range	4 - 6 mm
Standard lengths	50m coil

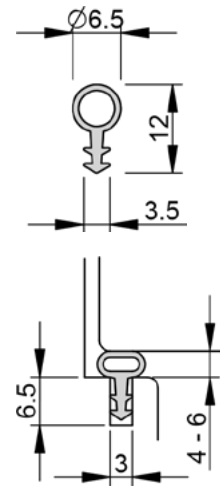

### FIXING

Fixing	into a groove in the door stop
--------	--------------------------------

### COLORS

Transparent

### ART.NO.

150002

# PS 0704 S

- / door stop-rebated bubble compression seal
- / large tolerance compensation
- / suitable for sound insulation
- / suitable for smoke sealing

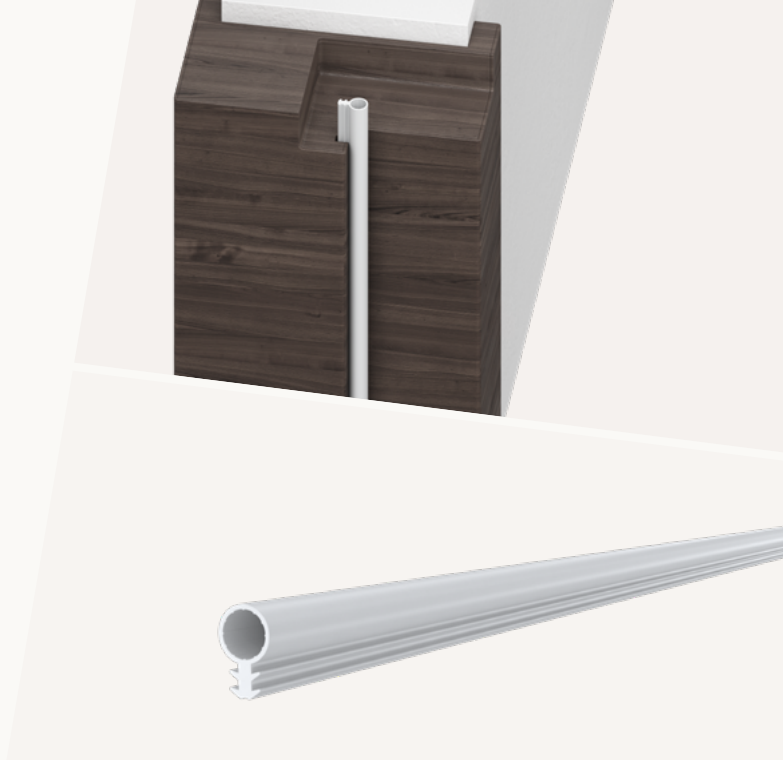

## TECHNICAL DATA

Application	timber frame rebates
Gasket material	silicone, self-extinguishing
Working temperature range	-40°C to +180°C

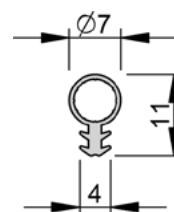

## DIMENSIONS

Width x height	7 x 11 mm
Fitting tolerance range	1.5 - 6.5 mm
Standard lengths	100m coil

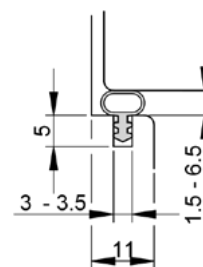

## FIXING

Fixing	into a groove in the door stop
--------	--------------------------------

## PERFORMANCE & CERTIFICATES

Fire	EN1634-1*
------	-----------

## COLORS

## ART.NO.

Black	P160057
Dark brown	P160056
Brown	P160214
White	P160065
Grey	P160080
Cream	P160215

\*The test value may differ according to the EN 1634-1 test, as the complete door system must be checked.

## PS 0805 S

- / door stop-rebated bubble compression seal
- / suitable for sound insulation
- / suitable for smoke sealing

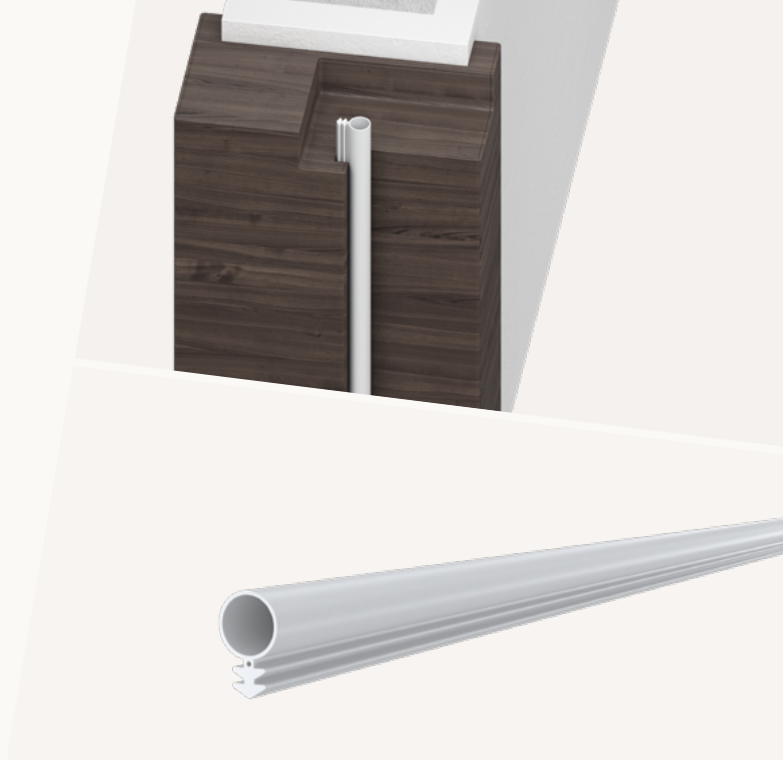

### TECHNICAL DATA

Application	timber frame rebates
Gasket material	silicone
Working temperature range	-60°C to +250°C

### DIMENSIONS

Width x height	8 x 12.5 mm
Fitting tolerance range	4 - 7 mm
Standard lengths	100m coil

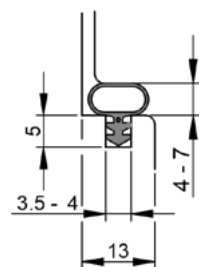
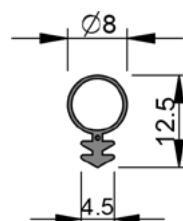

### FIXING

Fixing	into a groove in the door stop
--------	--------------------------------

### COLORS

COLORS	ART.NO.
Black	P160033
Brown	P160035
White	P160034

# PS 3645 P

- / double fin perimeter and meeting stile seal
- / suitable for sound insulation
- / suitable for smoke sealing

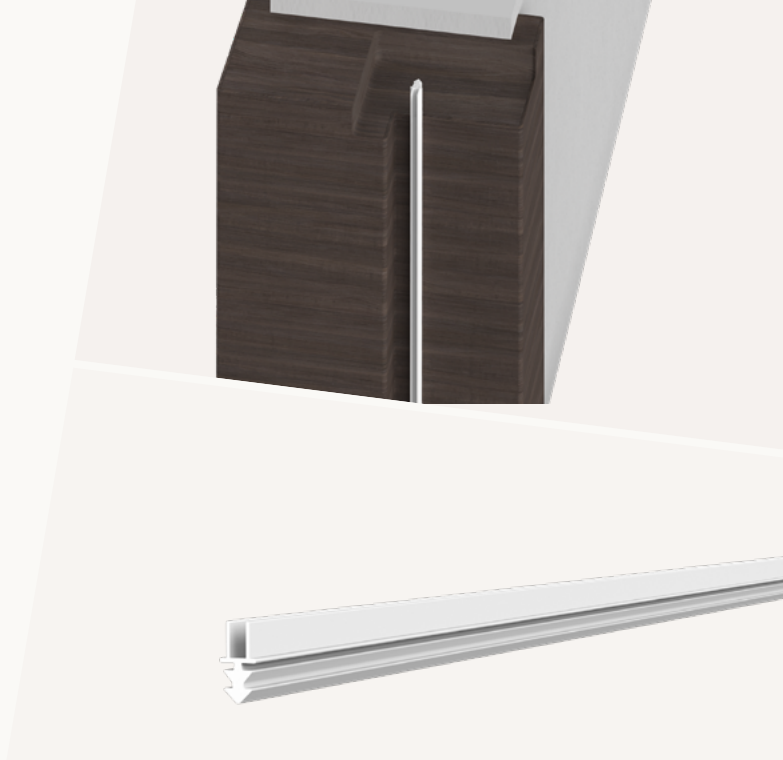

## TECHNICAL DATA

Application	timber frame & door rebates
Gasket material	rigid PVC base, flexible PVC fins
Working temperature range	-20°C to +60°C

## DIMENSIONS

Width x height	3.3 x 8 mm
Fitting tolerance range	2 - 4 mm
Standard lengths	2100, 2400, 3000 mm

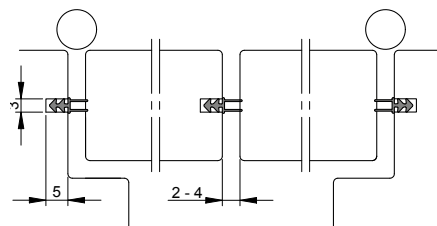
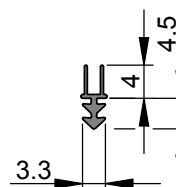

## FIXING

Fixing	into a groove in the door frame or door leaf
--------	--

## PERFORMANCE & CERTIFICATES

Fire	EN1634-1*
------	-----------

## COLORS

COLORS	ART.NO.
Black	P160036
Brown	P160156

\*The test value may differ according to the EN 1634-1 test, as the complete door system must be checked.

# PS 3665 P

- / double fin perimeter and meeting stile seal
- / suitable for sound insulation
- / suitable for smoke sealing



## TECHNICAL DATA

Application	timber frame & door rebates
Gasket material	rigid PVC base, flexible PVC fins
Working temperature range	-20°C to +60°C

## DIMENSIONS

Width x height	3.3 x 10 mm
Fitting tolerance range	4 - 6 mm
Standard lengths	2100, 2400, 3000 mm

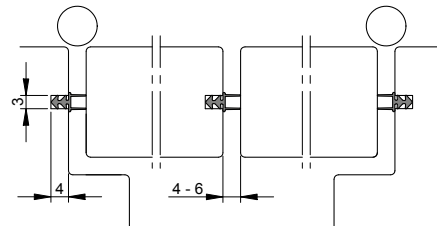
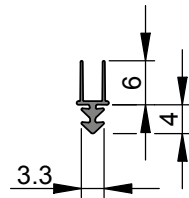

## FIXING

Fixing	into a groove in the door frame or door leaf
--------	--

## PERFORMANCE & CERTIFICATES

Fire	EN1634-1*
------	-----------

## COLORS

COLORS	ART.NO.
Black	P160058
Brown	P160155

1 Perimeter seals  
1.1 perimeter seals for installation in a groove



# ZD Universal

- / door stop-rebated compression seal
- / suitable for sound insulation
- / suitable for smoke sealing

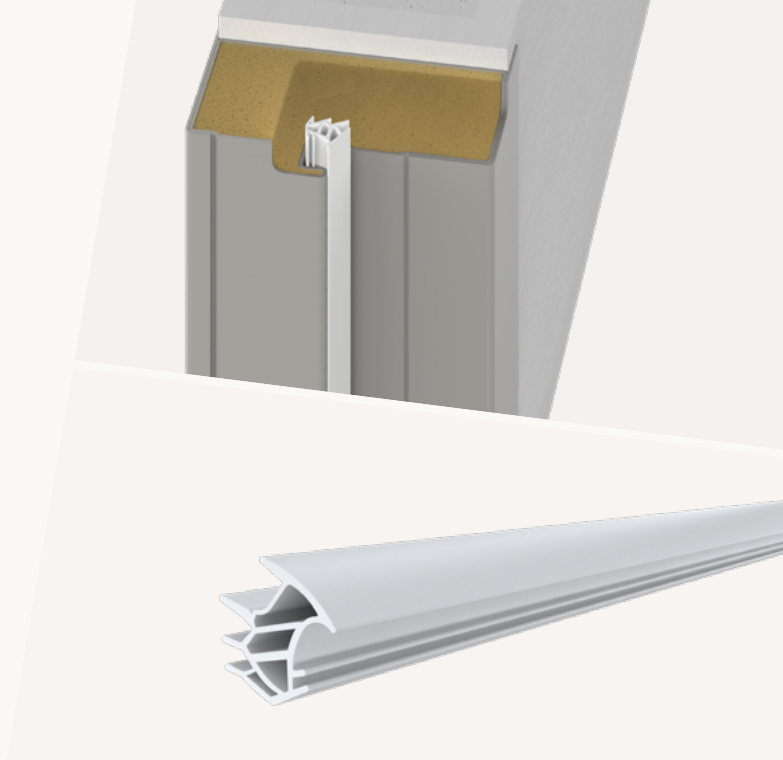

## TECHNICAL DATA

Application	metal frame rebates
Gasket material	TPE

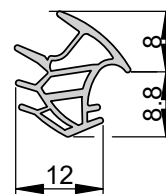

## DIMENSIONS

Width x height	12 x 16.8 mm
Fitting tolerance range	3 - 7 mm
Standard lengths	5m coil, 25m coil

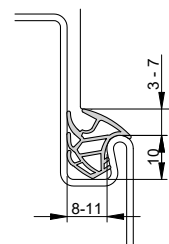

## FIXING

Fixing	into a groove in the door stop
--------	--------------------------------

LENGTHS	ART.NO.
5 m	370300
25 m	371300



## PS 1817 S

- / stop-rebated compression seal
- / suitable for sound insulation
- / suitable for smoke sealing

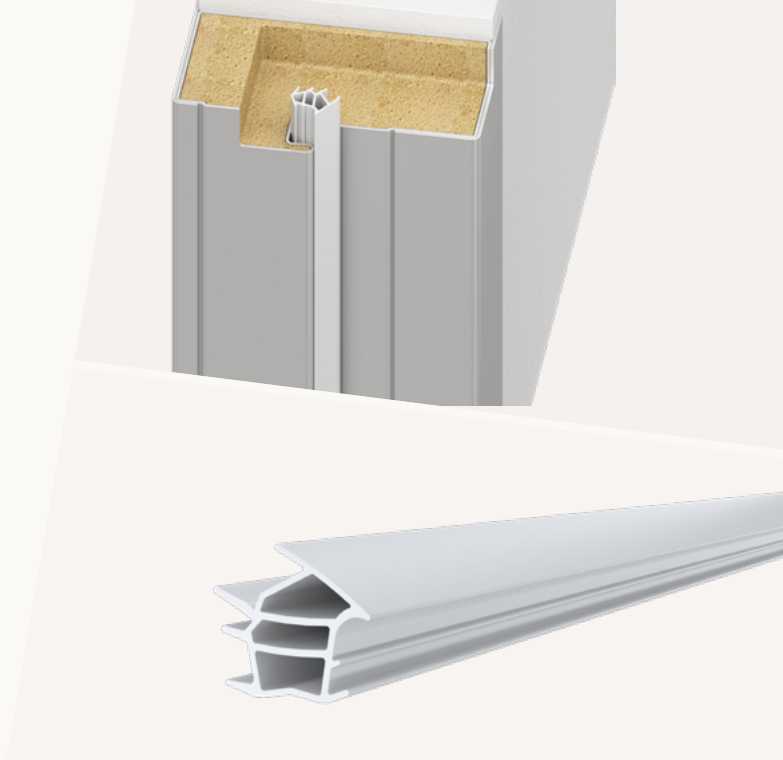

### TECHNICAL DATA

Application	metal frame rebates
Gasket material	silicone, self-extinguishing
Working temperature range	-40°C to +200°C

### DIMENSIONS

Width x height	18 x 18 mm
Fitting tolerance range	3 - 7 mm
Standard lengths	25m coil

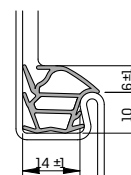
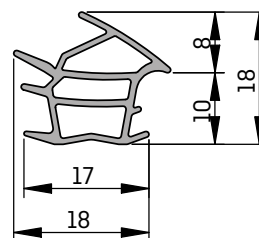

### FIXING

Fixing	into a groove in the door stop
--------	--------------------------------

### PERFORMANCE & CERTIFICATES

UL	UL 10C (R38166)
----	-----------------

### COLORS

### ART.NO.

Black	P160187
Grey	P160145
White	P160188



# PS 788 S

- / frame-mounted teardrop compression seal
- / equipped with a durable self-adhesive backing tape
- / suitable for sound insulation and smoke sealing
- / ensures soft closing of the door
- / also suitable for retro-fit applications

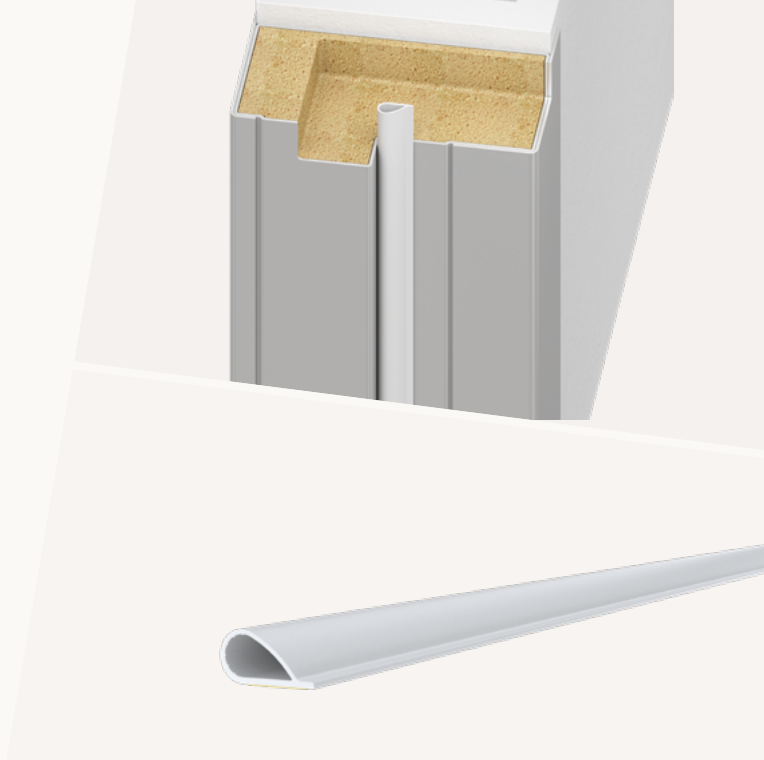

## TECHNICAL DATA

Application	timber & metal door frames
Gasket material	silicone, self-extinguishing
Working temperature range	-20°C to +80°C

## DIMENSIONS

Width x height	12.8 x 6.4 mm
Fitting tolerance range	2 - 5.5 mm
Standard lengths	50m coil

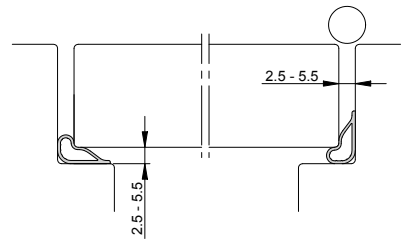
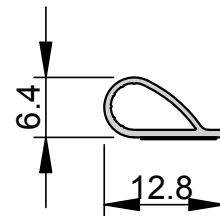

## FIXING

Fixing	stuck to the door stop with self-adhesive backing tape
--------	--

## PERFORMANCE & CERTIFICATES

Fire	EN1634-1**
UL	UL10C (R38166)

## COLORS

## ART.NO.

Black	P160040
Grey	P160078
White	P160042
Brown	P160041
Dark brown	P160041
Brown	P160216
Cream	P160217

\*\*The test value may differ according to the EN 1634-1 test, as the complete door system must be checked.

# PS 1108 S

- / single fin seal
- / equipped with a durable self-adhesive backing tape
- / suitable for sound insulation and for smoke sealing
- / well suited to tighter gaps and as a second frame seal
- / also suitable for retro-fit applications

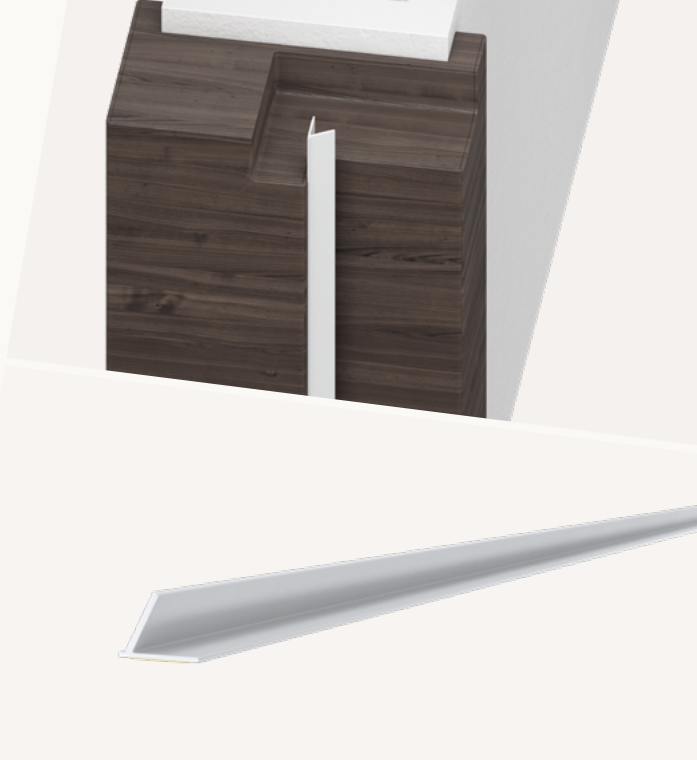

## TECHNICAL DATA

Application	timber & metal door frames
Gasket material	silicone, self-extinguishing
Working temperature range	-20°C to +80°C

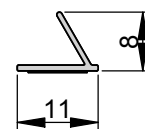

## DIMENSIONS

Width x height	11 x 8 mm
Fitting tolerance range	2.5 -7 mm
Standard lengths	6 m, 50 m coil

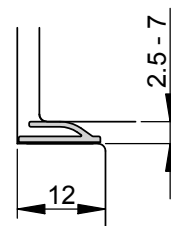

## FIXING

Fixing	stuck to the door stop with self-adhesive backing tape
--------	--

## COLORS

COLORS	ART.NO.
Black	P160227
Brown	P160226
White	P160228
Grey	P160229
Dark brown	P160225
Cream	P160230



**PS 1010 P**  
**PS 1212 P**  
**PS 1515 P**

- / winged corner seal
- / equipped with two rows of durable self-adhesive backing tape
- / suitable for sound insulation and for smoke sealing
- / ensures soft closing of the door
- / also suitable for retro-fit applications

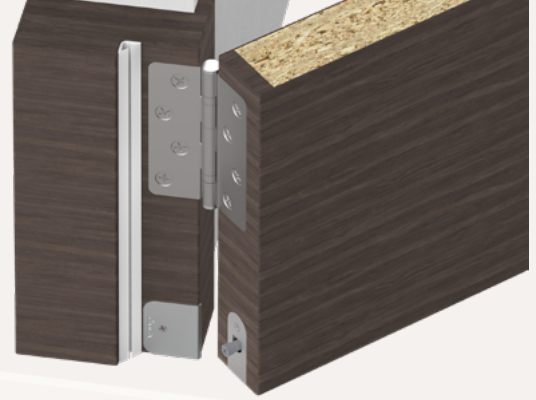

**TECHNICAL DATA**

Application	timber & metal door frames
Gasket material	rigid PVC base, flexible PVC fins
Working temperature range	-15°C to +60°C

**DIMENSIONS**

Standard lengths	2100, 2400, 3000 mm
------------------	---------------------

**FIXING**

Fixing	stuck to the door stop with self-adhesive backing tape
--------	--

**PERFORMANCE & CERTIFICATES**

UL	UL 10C (R38166)
Fire	EN1634-1*

<b>COLORS/ART.NO.</b>	<b>PS 1010 P</b>	<b>PS 1212 P</b>	<b>PS 1515 P</b>
Black	P160043	P160046	P160049
Dark brown	P160044	P160047	P160050
White	P160045	P160048	P160051

\*The test value may differ according to the EN 1634-1 test, as the complete door system must be checked.



	PS 1010 P	PS 1212 P	PS 1515 P
Fitting tolerance range	3 - 4 mm	3 - 4 mm	3 - 4 mm
Width x height	10 x 10 mm	12 x 12 mm	15 x 15 mm

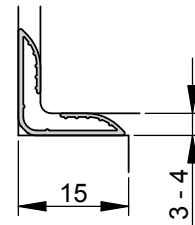
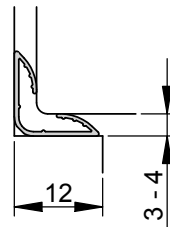
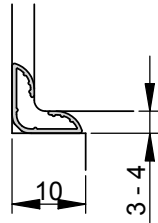
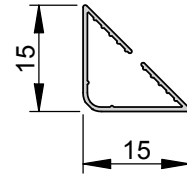
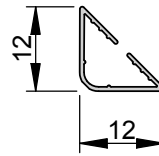
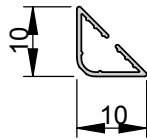



**PS 1010 P Flex**  
**PS 1212 P Flex**  
**PS 1515 P Flex**

- / winged corner seal with flexible base
- / equipped with two rows of durable self-adhesive backing tape
- / flexible base offers more flexibility during installation
- / ensures soft closing of the door
- / also suitable for retro-fit applications



**TECHNICAL DATA**

Application	timber and metal door frames
Gasket material	rigid and flexible PVC co-extrusion
Working temperature range	-15°C to +60°C

**DIMENSIONS**

Standard lengths	2100, 2200, 2400, 2500, 3000 mm
------------------	---------------------------------

**FIXING**

Fixing	stuck to the door stop with self-adhesive backing tape
--------	--

**PERFORMANCE & CERTIFICATES**

UL	UL 10C (R38166)
----	-----------------

COLORS/ART.NO.	PS 1010 P Flex	PS 1212 P Flex	PS 1515 P Flex
Black	P160130	P160136	P160138
Dark brown	P160132	P160137	P160139
Brown	P160211	P160209	P160210
White	P160131	P160135	P160140
Grey	P160159	P160147	P160151
Cream	P160160	P160146	P160161



	PS 1010 P Flex	PS 1212 P Flex	PS 1515 P Flex
Fitting tolerance range	2 - 4 mm	2 - 4 mm	2 - 4 mm
Width x height	10 x 10 mm	12 x 12 mm	15 x 15 mm

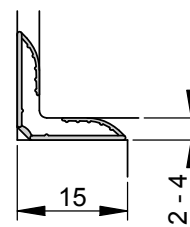
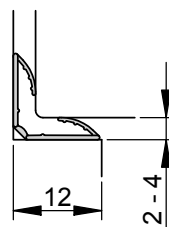
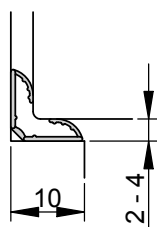
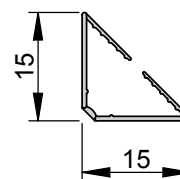
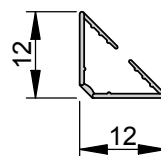
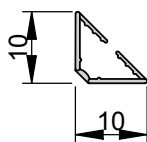





# PS 744 S

- / single fin seal
- / equipped with a durable self-adhesive backing tape
- / suitable for sound insulation and for smoke sealing
- / well suited to tighter gaps and as a second frame seal
- / also suitable for retro-fit applications

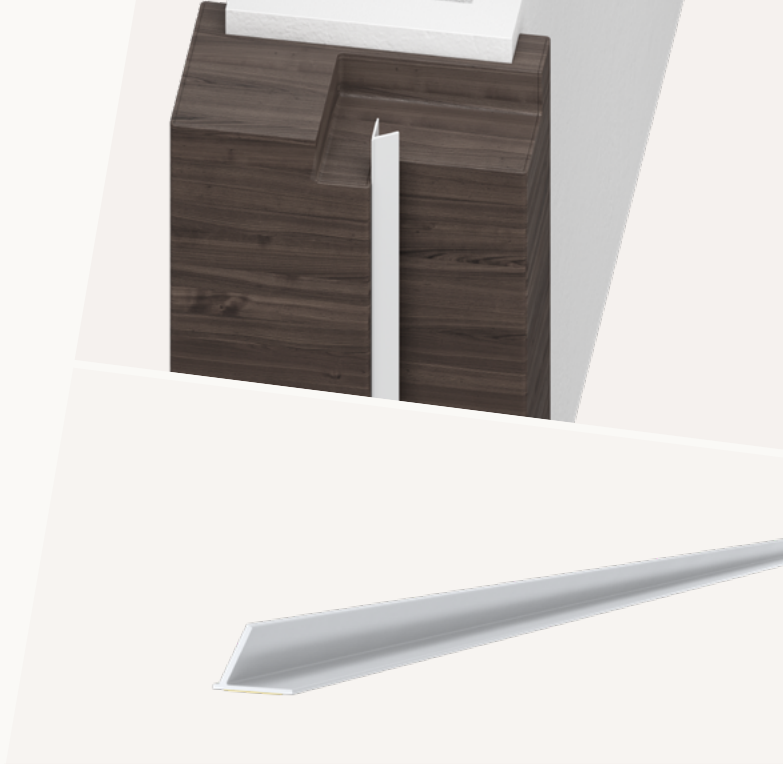

## TECHNICAL DATA

Application	timber & metal door frames
Gasket material	silicone, self-extinguishing
Working temperature range	-20°C to +80°C

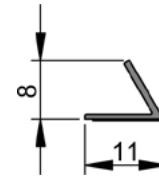

## DIMENSIONS

Width x height	11 x 8 mm
Fitting tolerance range	3 -7 mm
Standard lengths	62m coil, 155m coil

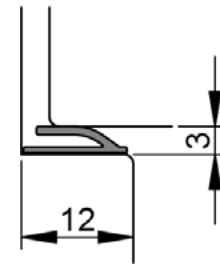

## FIXING

Fixing	stuck to the door stop with self-adhesive backing tape
--------	--

## PERFORMANCE & CERTIFICATES

UL	UL 10C (R38166)
----	-----------------

## COLORS

## ART.NO.

black	P160104
Brown	P160102
White	P160105
Light grey	P160103



# PS 1310 S

- / triple fin seal
- / equipped with a durable self-adhesive backing tape
- / suitable for sound insulation
- / suitable for smoke protection
- / also suitable for retro-fit applications

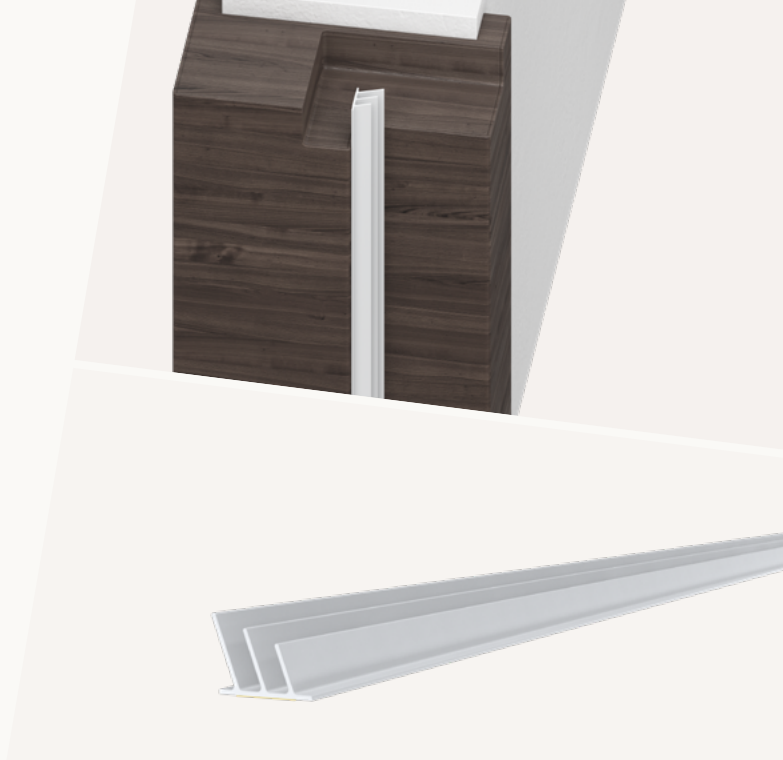

## TECHNICAL DATA

Application	timber & metal door frames
Gasket material	silicone, self-extinguishing
Working temperature range	-20°C to +80°C

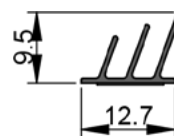

## DIMENSIONS

Width x height	12.7 x 9.5 mm
Fitting tolerance range	2 -7 mm
Standard lengths	62m coil, 155m coil

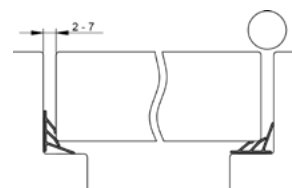

## FIXING

Fixing	stuck to the door stop with self-adhesive backing tape
--------	--

## PERFORMANCE & CERTIFICATES

UL	UL 10C (R38166)
----	-----------------

## COLORS

## ART.NO.

Black	P160113
Brown	P160111
White	P160114
Light grey	P160112

1 Perimeter seals  
1.2 self-adhesive perimeter seals

athmer.com

## PS 810 TE

- / stop-mounted compression seal
- / equipped with a durable self-adhesive backing tape
- / suitable for sound insulation and for smoke sealing
- / ensures soft closing of the door
- / also suitable for retro-fit applications

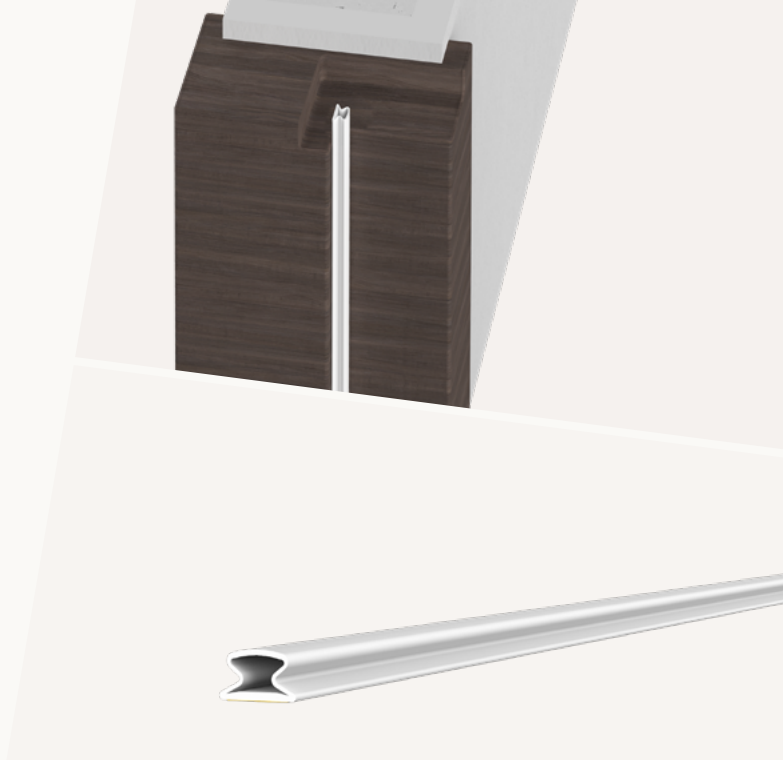

### TECHNICAL DATA

Application	timber frames
Gasket material	TPE
Working temperature range	-20°C to +80°C

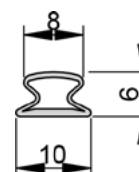

### DIMENSIONS

Width x height	10 x 6 mm
Fitting tolerance range	3.5 - 5 mm
Standard lengths	200m coil

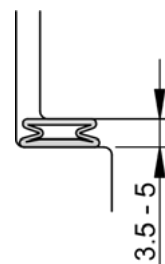

### FIXING

Fixing	stuck to the door stop with self-adhesive backing tape
--------	--

### COLORS

COLORS	ART.NO.
Black	P160061
Brown	P160066
White	P160059
Grey	P160060

## PS 812 TE

- / stop-mounted compression seal
- / equipped with a durable self-adhesive backing tape
- / suitable for sound insulation and for smoke sealing
- / ensures soft closing of the door
- / also suitable for retro-fit applications

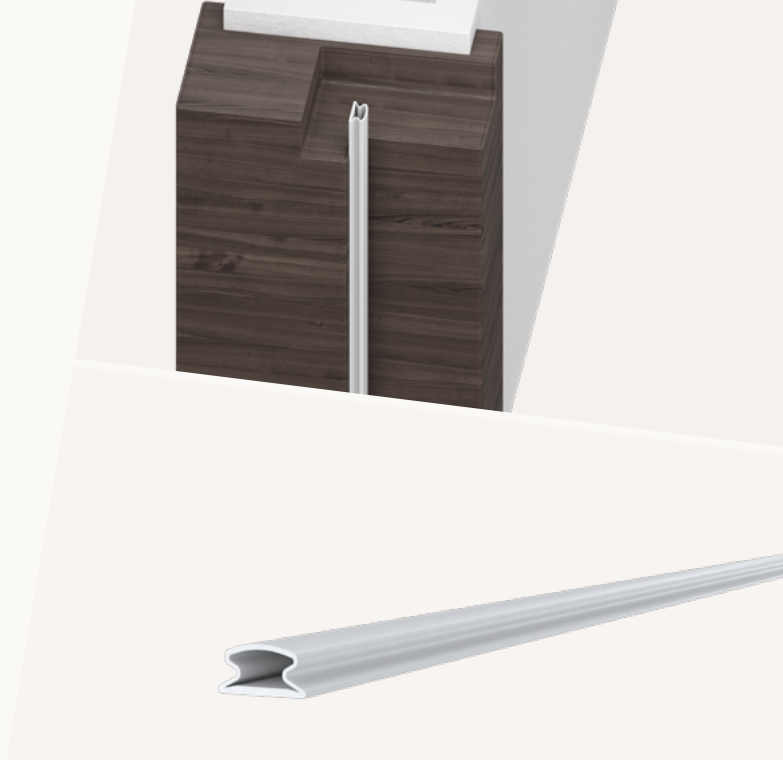

### TECHNICAL DATA

Application	timber frames
Gasket material	TPE
Working temperature range	-20°C to +80°C

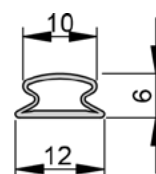

### DIMENSIONS

Width x height	12 x 6 mm
Fitting tolerance range	3.5 - 5 mm
Standard lengths	100m coil

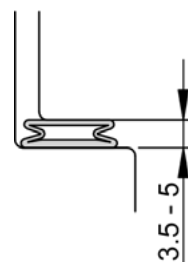

### FIXING

Fixing	stuck to the door stop with self-adhesive backing tape
--------	--

### COLORS

COLORS	ART.NO.
Black	P160064
Brown	P160063
White	P160062

### **UPGRADE EXISTING DOORS**

- / Improves the sound insulation and smoke control of existing doors

### **EASE OF INSTALLATION**

- / Install on existing doors without the need to dismantle the complete door system



# **NADI<sup>®</sup>**

## **RETROFIT SEALING SOLUTION**

### **SLIMLINE, DISCREET & STYLISH**

- / Slimline design and pre-finished features enable maximum architectural freedom and simple installation

### **FUTURE-PROOF & MAINTENANCE-FREE**

- / Uneven gaps caused by door warping can be overcome automatically, ensuring future technical performance

### **NATURALLY CERTIFIED**

- / Reference smoke testing in accordance with EN 1634-3 showcases suitability as a smoke seal for existing fire doors

### **BUDGET CERTAINTY**

- / Nadi® is priced & supplied per set, rather than per linear metre, offering maximum budget certainty



## Nadi® LM

## Nadi® FM

- / retrofit perimeter and meeting stile seal for reveal mounting
- / spring mechanism automatically adjusts up to 10mm to offset door warping (optionally 14mm)
- / Elongated holes, snap-on cover plate and pre-formed corners for easy installation
- / sets available for both single and double doors

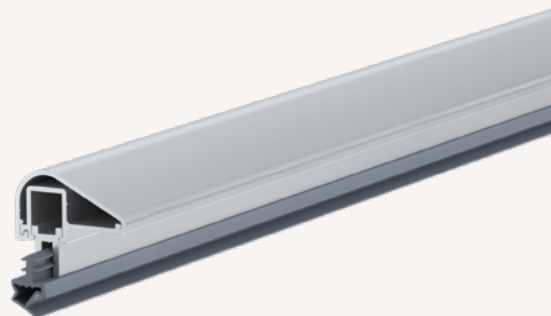
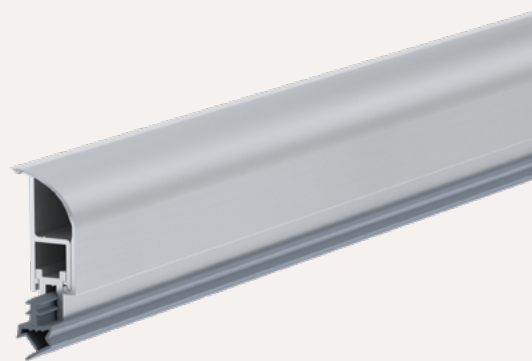

### DIMENSIONS

#### Nadi® LM

#### Nadi® FM

Tolerance compensation 10 mm (optionally 14 mm)

Width & height, actuated 10,3 & 29 mm

25,4 & 18 mm

### TECHNICAL DATA

#### Nadi® LM

#### Nadi® FM

Application hinged timber & metal doors

Material self-extinguishing, flame retardant silicone

Fixing mounted to the frame on closing face, screw fixed

mounted to the frame reveal on closing face, screw fixed

Performance Smoke: EN 1634-3

Can be shortened 150 mm

## SET COMPONENTS

/ Nadi® LM

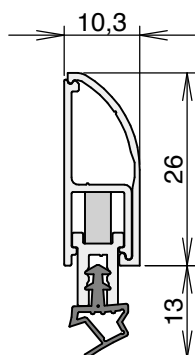

/ Nadi® FM

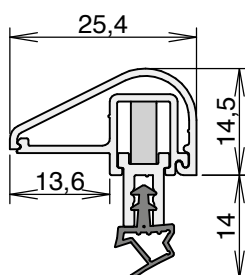

## LENGTHS/ART.NO.

	Nadi® LM set	Nadi® FM set	
Single-leaf door (mm)	H 2,100 x W 650 - 950	320 200	320 235
	H 2,100 x W 951 - 1,250	320 201	320 236
	H 2,100 x W 1,251 - 1,500	320 202	320 237
	H 2,400 x W 650 - 950	320 208	320 238
	H 2,400 x W 951 - 1,250	320 209	320 239
	H 2,400 x W 1,251 - 1,500	320 210	320 240
	H 2,700 x W 650 - 950	320 216	320 241
	H 2,700 x W 951 - 1,250	320 217	320 242
	H 2,700 x W 1,251 - 1,500	320 218	320 243
	H 3,000 x W 650 - 950	320 225	320 244
	H 3,000 x W 951 - 1,250	320 226	320 245
	H 3,000 x W 1,251 - 1,500	320 227	320 246
	Double-leaf door (mm)	H 2,100 x W 951-1,250	320 203
H 2,100 x W 1,251 - 1,500		320 204	320 248
H 2,100 x W 1,501 - 1,800		320 205	320 249
H 2,100 x W 1,801 - 2,100		320 206	320 250
H 2,100 x W 2,101 - 2,400		320 207	320 251
H 2,100 x W 2,401 - 2,700		320 316	-
H 2,400 x W 951 - 1,250		320 211	320 252
H 2,400 x W 1,251 - 1,500		320 212	320 253
H 2,400 x W 1,501 - 1,800		320 213	320 254
H 2,400 x W 1,801 - 2,100		320 214	320 255
H 2,400 x W 2,101 - 2,400		320 215	320 256
H 2,400 x W 2,401 - 2,700		320 317	-
H 2,700 x W 951 - 1,250		320 219	320 257
H 2,700 x W 1,251 - 1,500		320 220	320 258
H 2,700 x W 1,501 - 1,800		320 221	320 259
H 2,700 x W 1,801 - 2,100		320 222	320 260
H 2,700 x W 2,101 - 2,400		320 223	320 261
H 2,700 x W 2,401 - 2,700		320 224	320 262
H 3,000 x W 951 - 1,250		320 228	320 263
H 3,000 x W 1,251 - 1,500		320 229	320 264
H 3,000 x W 1,501 - 1,800	320 230	320 265	
H 3,000 x W 1,801 - 2,100	320 231	320 266	
H 3,000 x W 2,101 - 2,400	320 232	320 267	
H 3,000 x W 2,401 - 2,700	320 233	320 268	
H 3,000 x W 2,701 - 3,000	320 234	320 269	

Further sets on request.

1 Perimeter seals  
1.3 surface mounted perimeter seals

athmer.com





# PS 2807 S

- / surface-mounted acoustic perimeter seal for fitting around the head and jambs of existing doors
- / slim design
- / with elongated fixing holes for easy positioning and adjustment
- / fixing screws concealed by snap on cover
- / also suitable for retro-fit applications

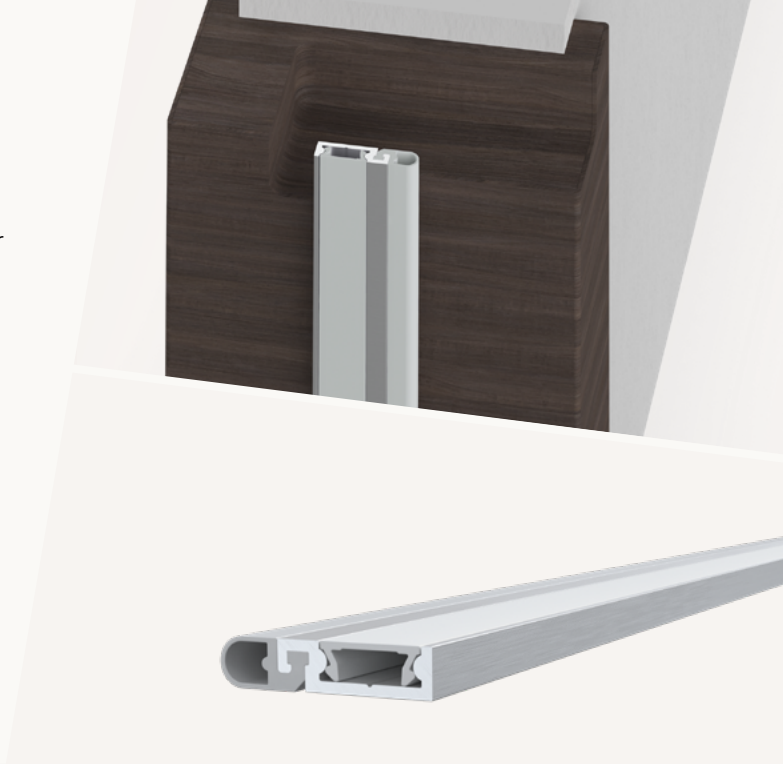

## TECHNICAL DATA

Application	timber & metal frames
Gasket material	silicone self-extinguishing
Carrier material	aluminum, anodized
Working temperature range	-40°C to +200°C

## DIMENSIONS

Width x height	28 x 6 mm
Fitting tolerance range	2 - 6 mm
Standard lengths	1.000, 2.100, 2.250, 2.500, 3.000 mm
Max. lengths	3.000 mm
Can be shortened by	any lengths

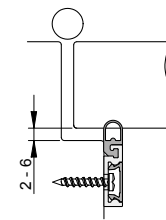
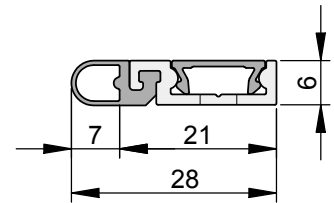

## FIXING

Fixing	surface mounted to the door frame, screw fixed
--------	--

## PERFORMANCE & CERTIFICATES

UL	UL 10C (R38166)
----	-----------------

COLORS (carrier, gasket)	ART.NO.	ACCESSORIES (incl. in delivery)
Silver anodized, grey	8-111	S019
Black anodized, black	8-112	S019



# PS 3607 S

- / surface-mounted acoustic perimeter seal for fitting around the head and jambs of existing doors
- / slim design
- / with elongated fixing holes for easy positioning and adjustment
- / fixing screws concealed by a snap on cover profile made of anodized aluminum
- / also suitable for retro-fit applications

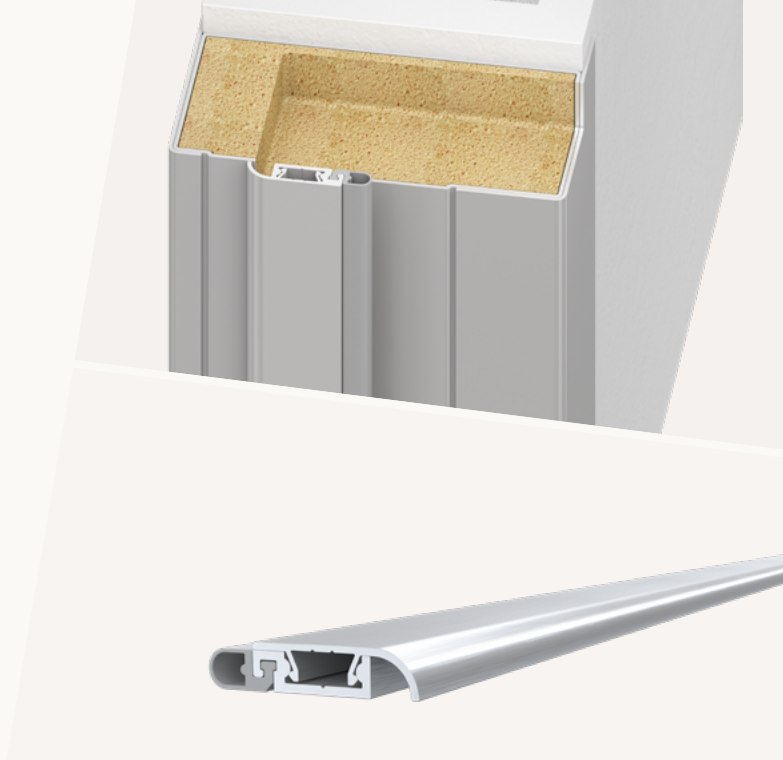

## TECHNICAL DATA

Application	timber & metal frames
Gasket material	silicone, self-extinguishing
Carrier material	aluminum, anodized
Working temperature range	-40°C to +200°C

## DIMENSIONS

Width x height	36 x 7 mm
Fitting tolerance range	2 - 6 mm
Standard lengths	1.000, 2.100, 2.250, 2.500, 3.000 mm
Maximum lengths	3.000 mm
Can be shortened by	any length

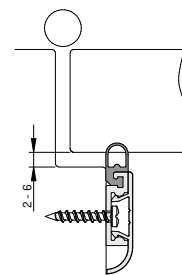
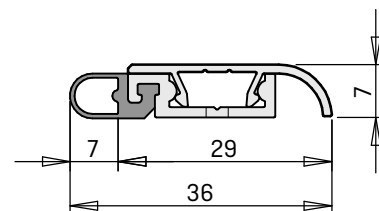

## FIXING

Fixing	surface mounted to the door frame, screw fixed
--------	--

## PERFORMANCE & CERTIFICATES

UL	UL 10C (R38166)
----	-----------------

COLORS (carrier, gasket)	ART.NO.	ACCESSORIES (incl. in delivery)
Silver anodized, grey	8-113	S019
Black anodized, black	8-114	S019



## PS 2816 S

- / surface-mounted acoustic perimeter seal for fitting around the head and jambs of existing doors
- / with elongated fixing holes for easy positioning and adjustment
- / fixing screws concealed by snap on cover
- / also suitable for retro-fit applications

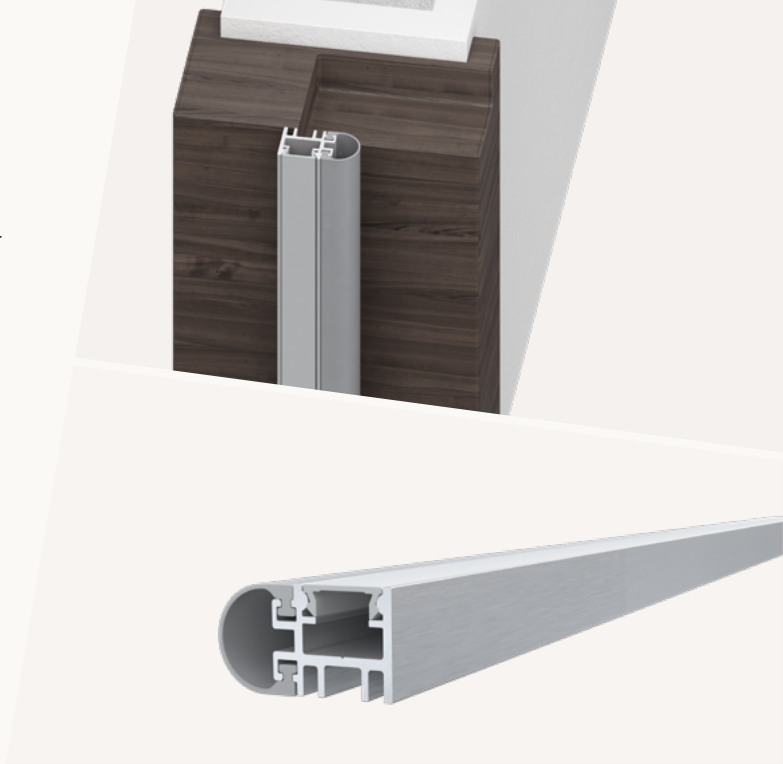

### TECHNICAL DATA

Application	timber & metal frames
Gasket material	silicone, self-extinguishing
Carrier material	aluminum, anodized
Working temperature range	-40°C to +200°C

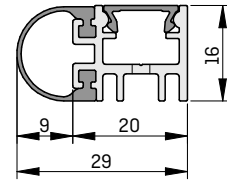

### DIMENSIONS

Width x height	29 x 16 mm
Fitting tolerance range	3 - 8 mm
Standard lengths	1.000, 2.100, 2.250, 2.500, 3.000 mm
Maximum lengths	3.000 mm
Can be shortened by	any length

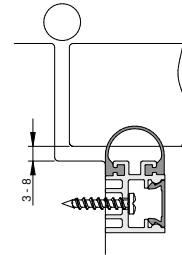

### FIXING

Fixing	surface mounted to the door frame, screw fixed
--------	--

### PERFORMANCE & CERTIFICATES

UL	UL 10C (R38166)
----	-----------------

COLORS (carrier, gasket)	ART.NO.	ACCESSORIES (incl. in delivery)
Silver anodized, grey	8-115	S023
Black anodized, black	8-116	S023

## Unitherm FAS-20

- / aluminium stop-mounted perimeter seal
- / anodised aluminium carrier
- / suitable for sound insulation
- / suitable for smoke protection

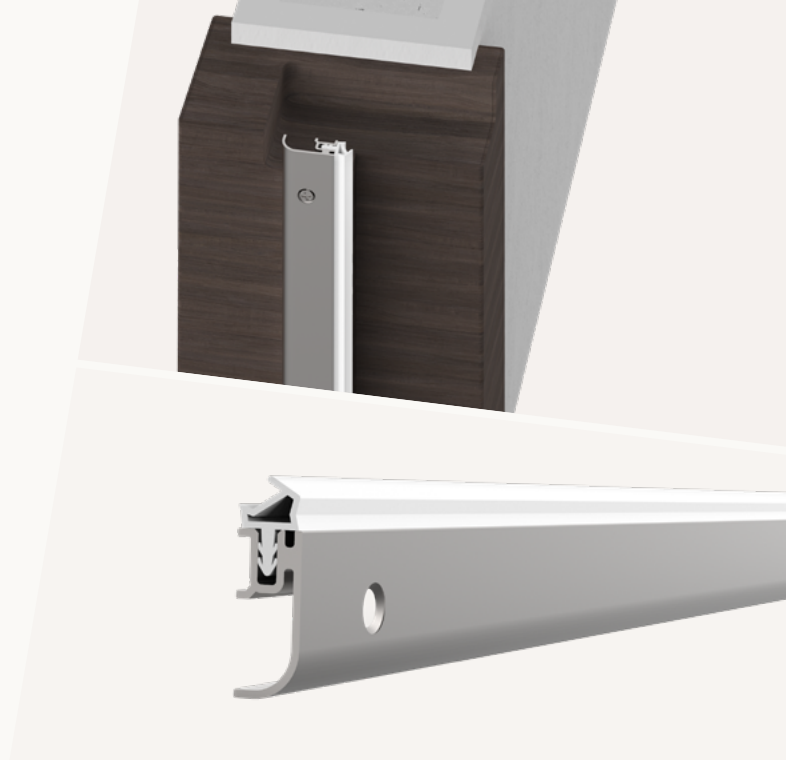

### TECHNICAL DATA

Application	timber and metal frames
Gasket material	TPE
Carrier material	aluminum

### DIMENSIONS

Width x height	8,5 x 26 mm
Standard lengths	2100 mm
Can be shortened by	any length

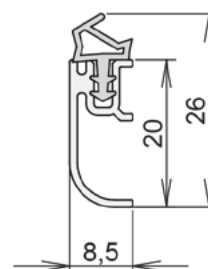

### FIXING

Fixing	surface mounted to the door frame, screw fixed
--------	--

<b>COLORS</b> [carrier, gasket]	<b>ART.NO.</b>
Silver anodized, grey	319204



# AS 2519 S

- / astragal/meeting stile seal
- / wide compression range
- / extremely low compression force for feather-light operation
- / also suitable for retro-fit applications

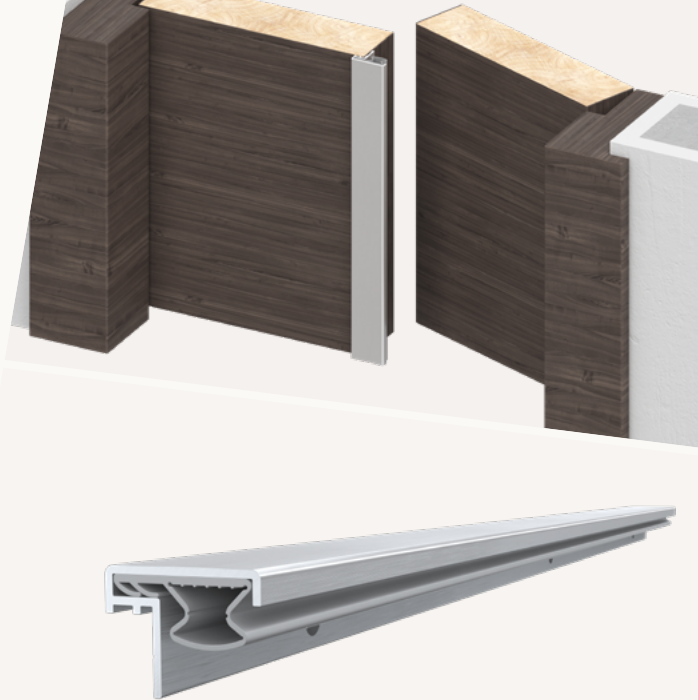

## TECHNICAL DATA

Application	double-leaf timber and metal doors
Gasket material	silicone self-extinguishing
Carrier material	aluminum, anodized
Working temperature range	-40°C to +200°C

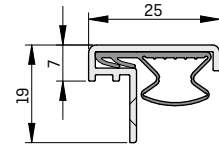

## DIMENSIONS

Width x height	25 x 19 mm
Fitting tolerance range	0 - 4.5 mm
Standard lengths	2.100, 2.250, 2.500, 3.000 mm
Max. lengths	3.000 mm
Can be shortened by	any lengths

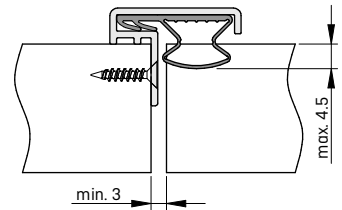

## FIXING

Fixing	screw fixed to the meeting stile of double wing doors
--------	---

## PERFORMANCE & CERTIFICATES

UL	UL 10C (R38166)
----	-----------------

COLORS (carrier, gasket)	ART.NO.	ACCESSORIES (incl. in delivery)
Silver anodized, grey	8-101	S020



# PS 2806 S

- / surface-mounted acoustic perimeter seal for fitting around the head and jambs of existing doors
- / slim design
- / triple fin gasket
- / with elongated fixing holes for easy positioning and adjustment
- / fixing screws concealed by snap on cover

## TECHNICAL DATA

Application	timber & metal frames
Gasket material	silicone self-extinguishing
Carrier material	aluminum, anodized
Working temperature range	-40°C to +200°C

## DIMENSIONS

Width x height	28 x 6 mm
Fitting tolerance range	3 - 6 mm
Standard lengths	1.000, 2.100, 2.250, 2.500, 3.000 mm
Max. lengths	3.000 mm
Can be shortened by	any lengths

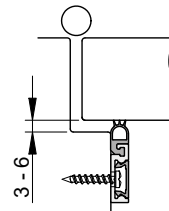
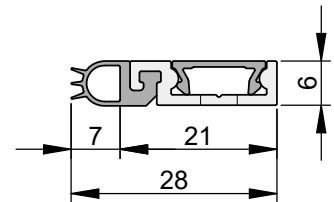

## FIXING

Fixing	surface mounted to the door frame, screw fixed
--------	--

## PERFORMANCE & CERTIFICATES

UL	UL 10C [R38166]
----	-----------------

COLORS [carrier, gasket]	ART.NO.	ACCESSORIES [incl. in delivery]
Silver anodized, grey	8-119	S019

## Pivot L-15 (set)

- / complete four-sided pivot hinge door solution
- / suitable with single- and double-acting doors
- / ground-breaking roller actuator suitable for various frame designs
- / set includes additional frame actuation roller for fitting to scalloped frames
- / supplied with magnetic seals for the vertical edges of door



DIMENSIONS	Schall-Ex® L-15/30 Pivot	Slide magnet
Travel	12 mm	
Gap size		6 mm

TECHNICAL DATA	Schall-Ex® L-15/30 Pivot	Slide magnet
Actuation	single	-
Material	self-extinguishing, flame retardant silicone	aluminium, silicone
Fixing	surface-mounted top and bottom	two part system surface-mounted to frame and door
Standard lengths	833, 958, 1,083, 1,208 mm (can be shortened 125 mm)	2,500 / 3,000 mm
Min/max lengths	235 mm / 2,000 mm	- / 3,000 mm
Accessories	5817	-



### SET COMPONENTS

/ Schall-Ex® L-15/30 WS Pivot (incl. roller actuator for frame)[2 pcs.]

/ Slide magnet [2 pc.]

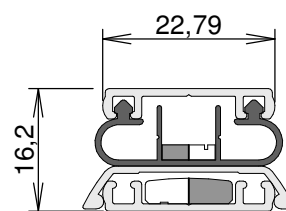
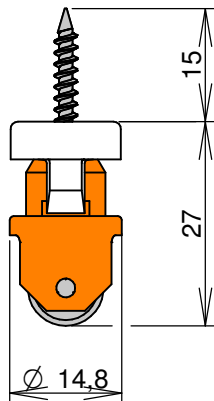
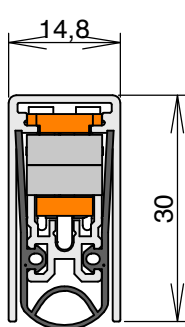

COLOURS/ART.NO.	Lengths slide magnet	
	2,500 mm	3,000 mm
Silver-colored, anod. (C-0)	1-1027	1-1028
Stainless steel-colored (C-31)	1-1029	1-1030

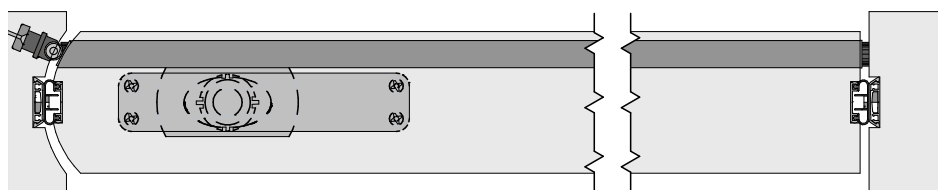

1 Perimeter seals  
1.4 perimeter seals for sliding and pivot doors



## Universal M-12 (set)

- / complete four-sided sliding door solution
- / can be fitted to timber, glass and metal doors
- / supplied with magnetic seals for the vertical edges of door
- / self-locking system - no additional latching or locking required



DIMENSIONS	Schall-Ex® Slide M-12 WS ZU	Slide magnet	Niroschwelle 365
Travel	11 mm		
Height x width	13,7 x 48,5 mm	28 x 29 mm	40 x 2,5 mm

TECHNICAL DATA	Schall-Ex® Slide M-12 WS ZU	Slide magnet	Niroschwelle 365
Actuation	single	-	-
Material	self-extinguishing, flame retardant silicone	aluminium, silicone	stainless steel
Fixing	surface-mounted top and bottom	two part system surface-mounted to frame and door	
Standard lengths	Fixed lengths only (cannot be shortened)	2,500 / 3,000 mm	Fixed lengths only
Min/max lengths	450 mm / 1,500 mm	- / 3,000 mm	- / 1,500 mm
Accessories	5144	-	-



### SET COMPONENTS

/ Schall-Ex® Slide M-12 WS ZU [2 pcs.]

/ Slide magnet [2 pcs.]

/ Niroschwelle 365 [1 pc.]

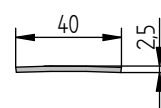
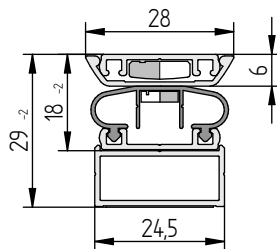
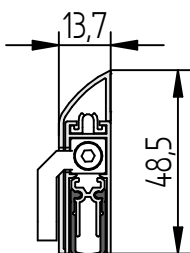

### COLOURS/ART.NO.

#### Lengths slide magnet

2,500 mm

3,000 mm

Silver-colored, anod. (C-0)

1-1015

1-1016

Stainless steel-colored (C-31)

1-1013

1-1014

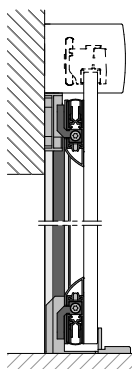

Glass door

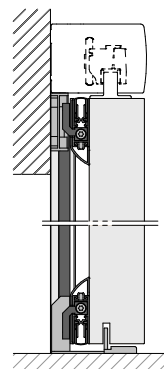
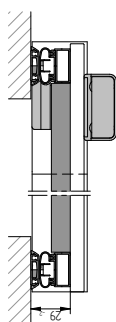

Timber door

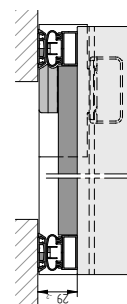

1 Perimeter seals  
1.4 perimeter seals for sliding and pivot doors

athmer.com

## VHH M-12 (set)

- / top and bottom drop seal set for sliding doors
- / additional adaptor supplied for top of door
- / can be fitted to pocket & wall-mounted doors
- / can be fitted to most roller systems utilising an M8 bolt connection
- / magnet supplied for use with unlatched doors
- / combine with ZD Slide 12/12 vertical seal (optional)



### DIMENSIONS

Groove width	12 mm
Travel	11 mm

### TECHNICAL DATA

#### Schall-Ex® Slide M-12 SLA

Application	sliding timber doors
Actuation	single
Material	self-extinguishing, flame retardant silicone
Fixing	Bottom: rebated into a groove in the door, screw fixed both sides Top: screw fixed with an adaptor
Standard lengths	708, 833, 958, 1,083, 1,208 mm (can be shortened: 125 mm)
Min/max lengths	280 mm / 1,958 mm
Accessories	5106
Art.No.	1-839

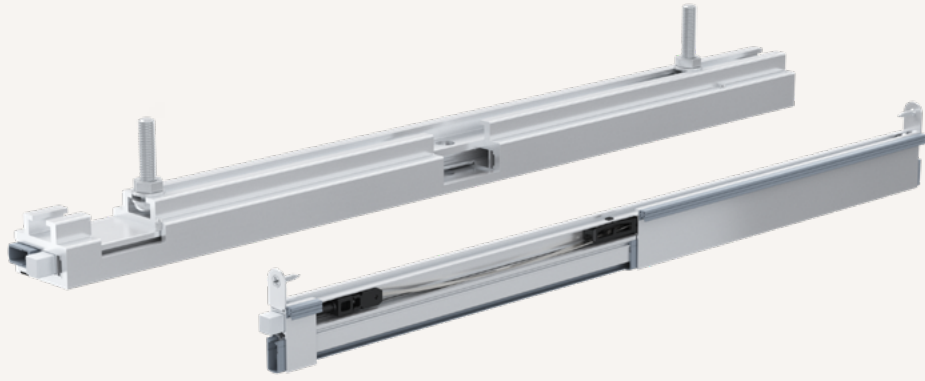

## SET COMPONENTS

/ Schall-Ex® Slide M-12 SLA [2 pcs.]

/ Slide adapter 12 [1 pc.]

/ M8 bolt and fixings [2 pcs.]

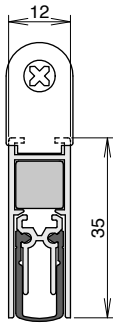

/ door guide [1 pc.]

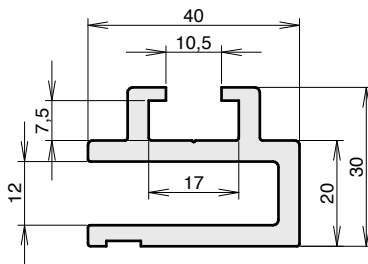

/ magnet [2 pcs.]



/ slide spacer [1 pc.]

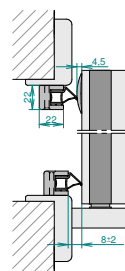
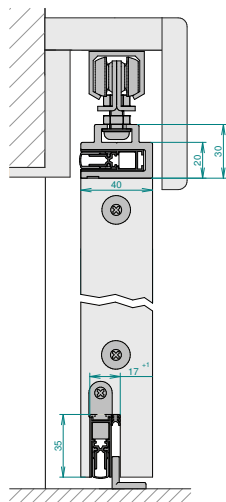

## ZD Slide 12/12

- / rebated sliding door perimeter seal
- / suitable for sound insulation
- / suitable for smoke sealing

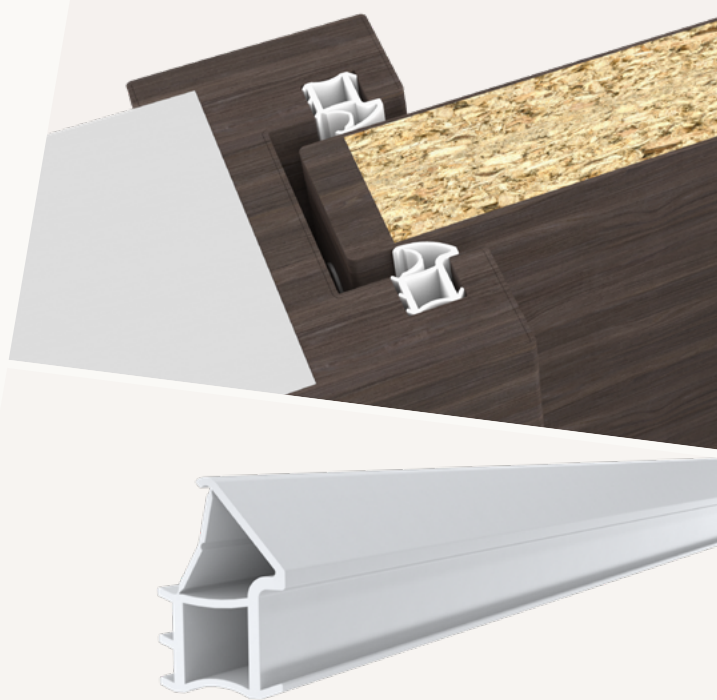

### TECHNICAL DATA

Application	timber and metal frame rebates
Gasket material	silicone

### DIMENSIONS

Width x height	16.5 x 25 mm
Fitting tolerance range	6 - 10 mm
Standard lengths	per meter

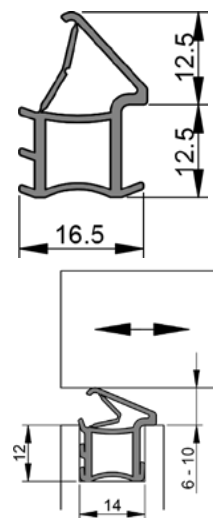

### FIXING

Fixing	into a groove in the sliding door frame
--------	---

### COLORS

Grey

### ART.NO.

210

## Slide VN 8/10

- / glass door-mounted perimeter seal
- / suitable for sound insulation
- / suitable for smoke sealing

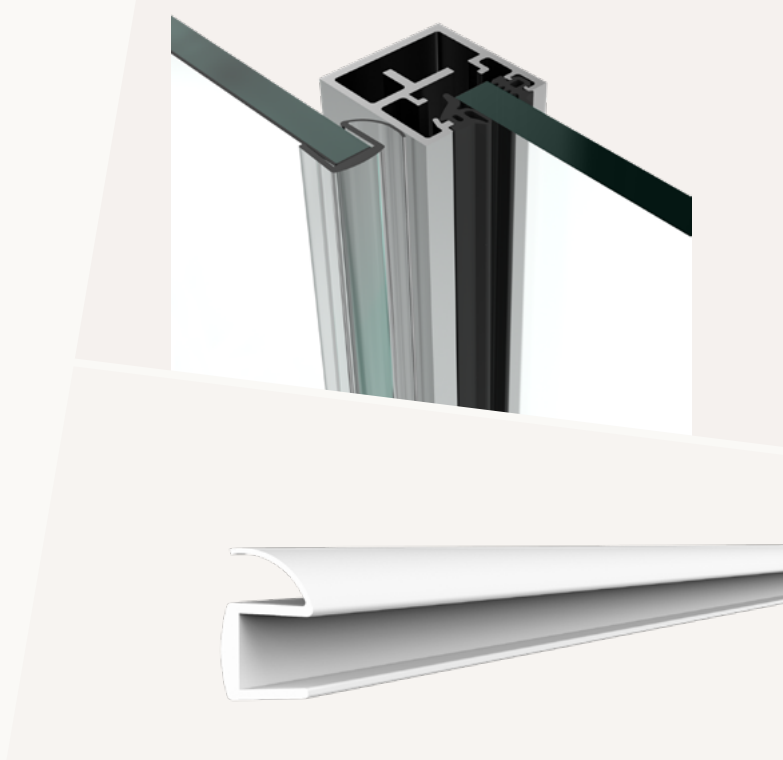

### TECHNICAL DATA

Application	frameless sliding glass doors
Gasket material	silicone

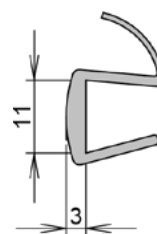

### DIMENSIONS

Fitting tolerance range	6 - 10 mm
Standard lengths	per metre

### FIXING

Fixing	slip onto the edge of the glass door
--------	--------------------------------------

### COLORS

Transparent

### ART.NO.

523